

Anatomy Test Sheets

8205 Skeleton

Name _____

Class _____

- 1 _____
- 2 _____
- 3 _____
- 4 _____
- 5 _____
- 6 _____
- 7 _____
- 8 _____
- 9 _____
- 10 _____
- 11 _____
- 12 _____
- 13 _____
- 14 _____
- 15 _____
- 16 _____
- 17 _____
- 18 _____
- 19 _____
- 20 _____
- 21 _____
- 22 _____
- 23 _____
- 24 _____
- 25 _____
- 26 _____
- 27 _____
- 28 _____
- 29 _____
- 30 _____
- 31 _____
- 32 _____
- 33 _____
- 34 _____
- 35 _____
- 36 _____
- 37 _____

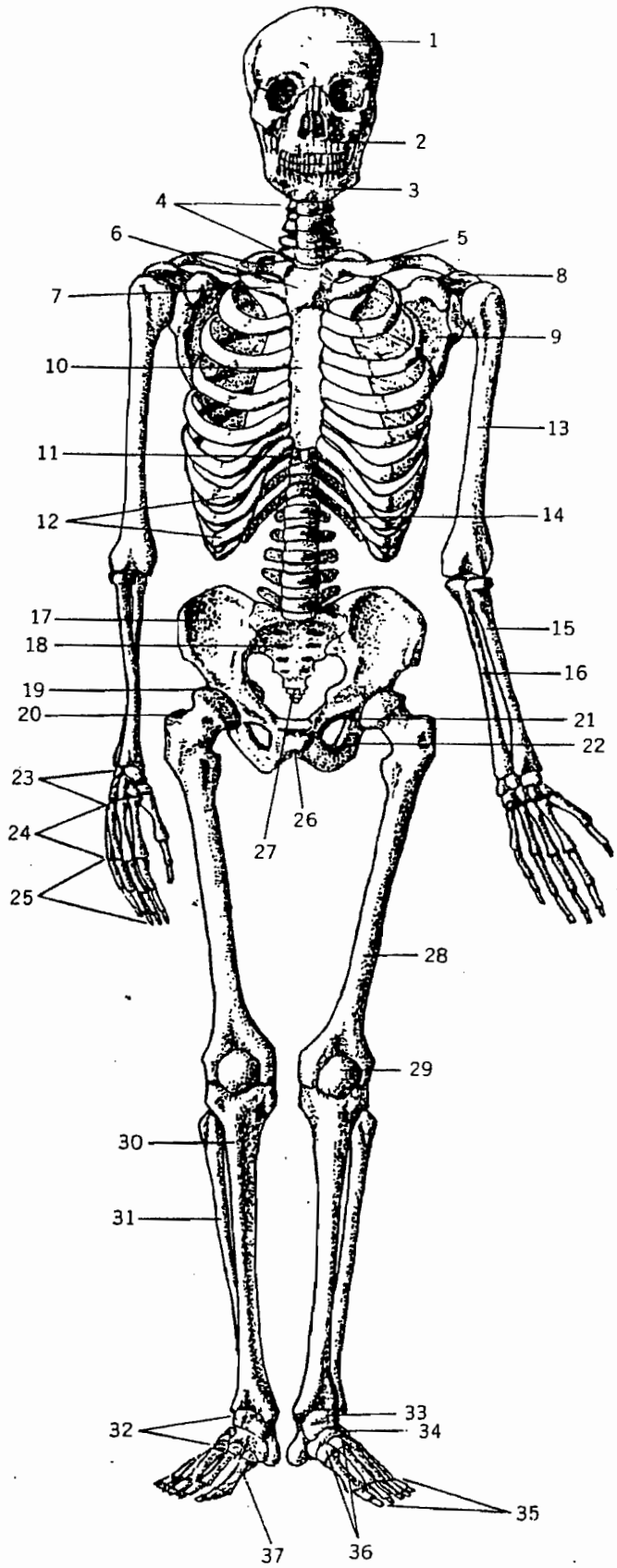

DENOYER-GEPPERT

CHICAGO, ILLINOIS 60640

Anatomy Test Sheets

8206 Skull, front view

Name _____

Class _____

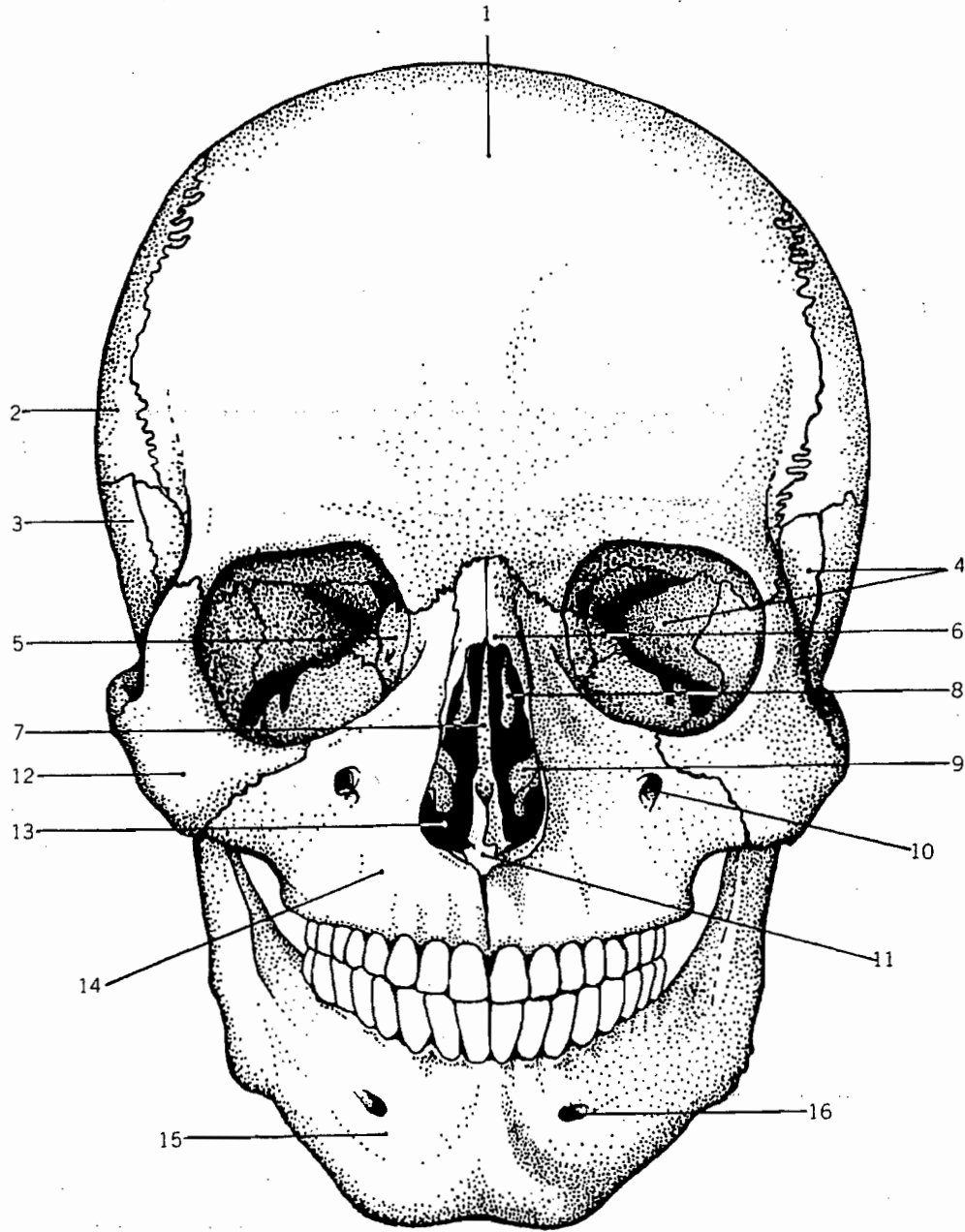

- 1 _____
- 2 _____
- 3 _____
- 4 _____
- 5 _____
- 6 _____
- 7 _____
- 8 _____

- 9 _____
- 10 _____
- 11 _____
- 12 _____
- 13 _____
- 14 _____
- 15 _____
- 16 _____

DENOYER-GEPPERT

CHICAGO, ILLINOIS 60640

Anatomy Test Sheets

8207 Skull, inferior surface

Name _____

Class _____

- 1 _____
- 2 _____
- 3 _____
- 4 _____
- 5 _____
- 6 _____
- 7 _____
- 8 _____
- 9 _____
- 10 _____
- 11 _____
- 12 _____
- 13 _____
- 14 _____
- 15 _____
- 16 _____
- 17 _____
- 18 _____
- 19 _____
- 20 _____
- 21 _____
- 22 _____
- 23 _____
- 24 _____
- 25 _____
- 26 _____
- 27 _____
- 28 _____
- 29 _____

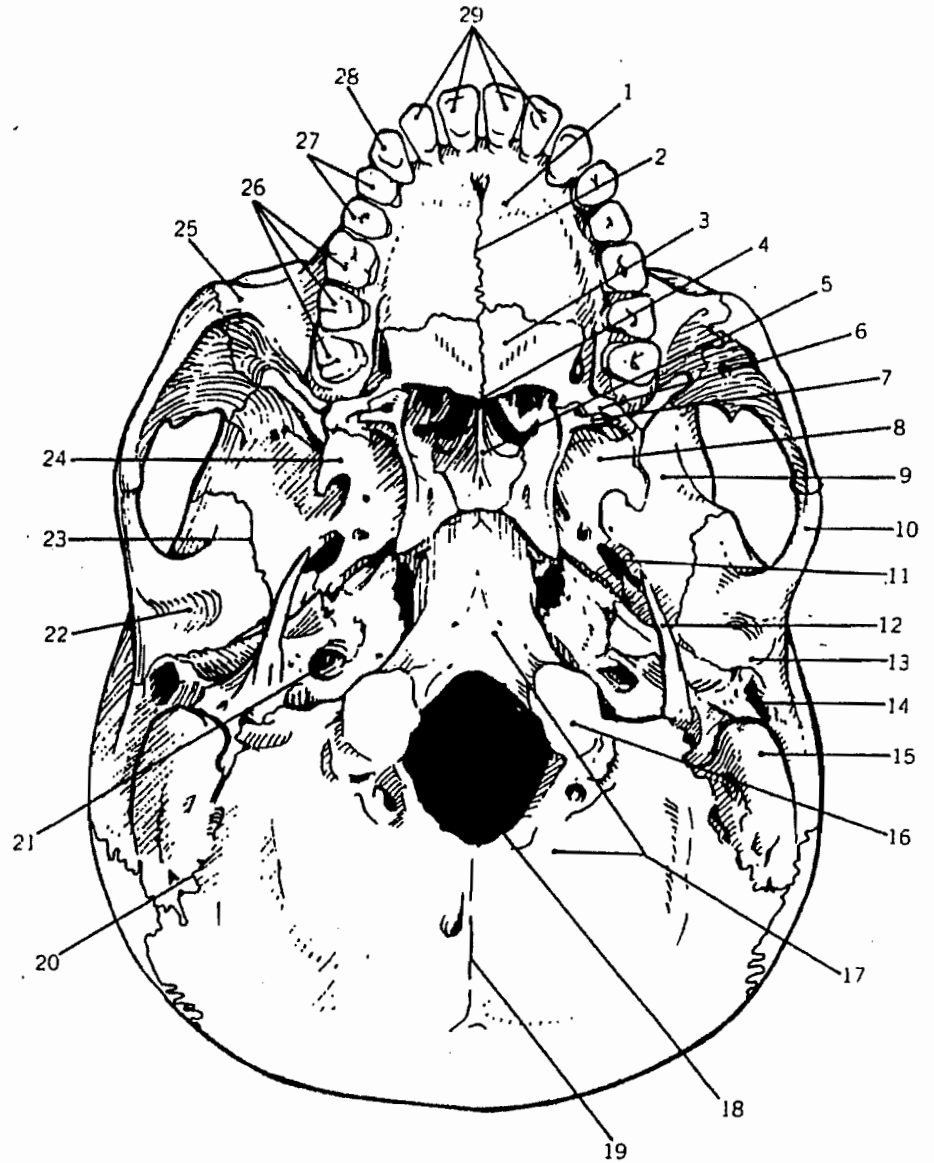

Anatomy Test Sheets

8208 Skull, sagittal views

Name _____

Class _____

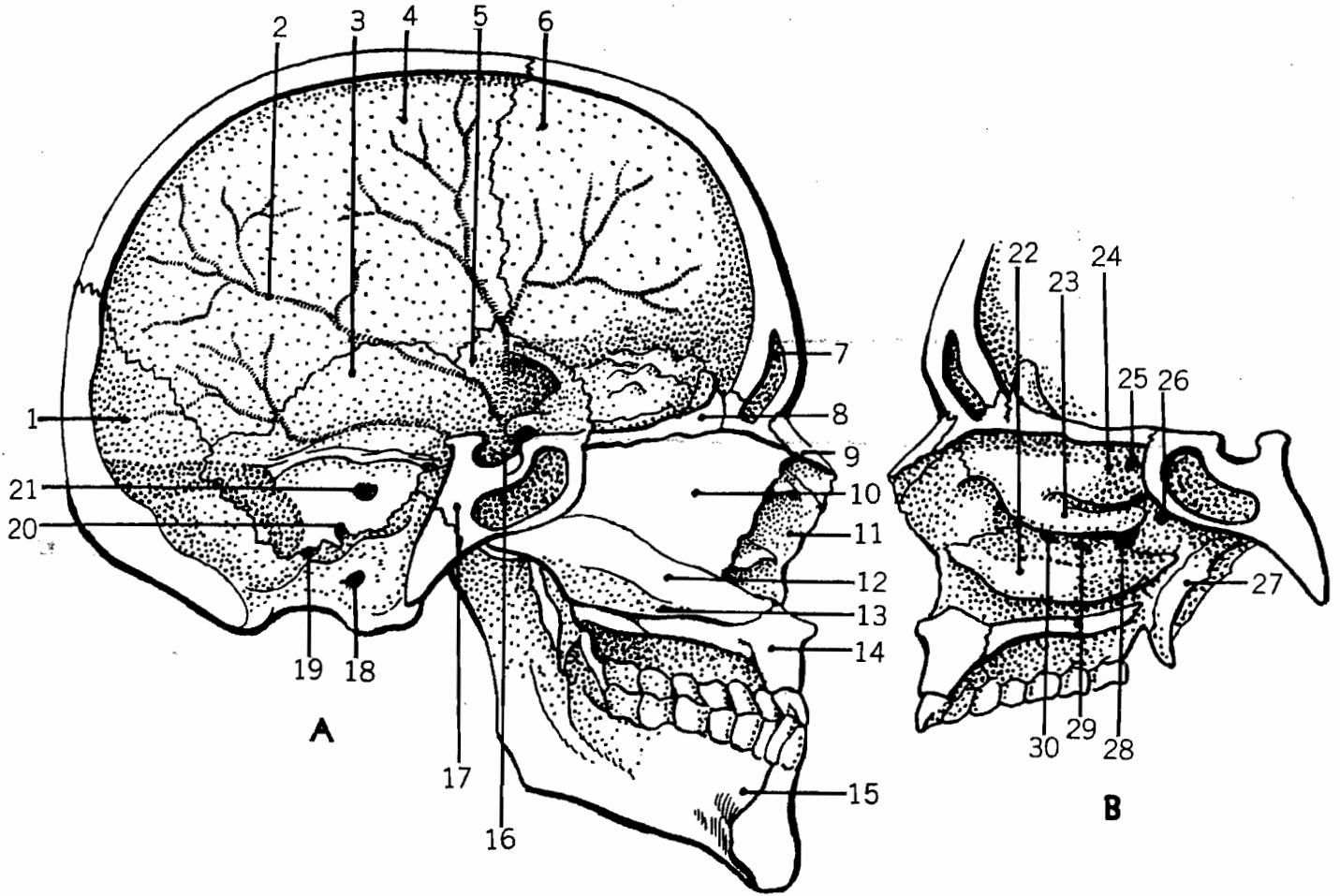

- Fig. A.....
- 1.....
 - 2.....
 - 3.....
 - 4.....
 - 5.....
 - 6.....
 - 7.....
 - 8.....
 - 9.....
 - 10.....
 - 11.....
 - 12.....
 - 13.....
 - 14.....

- 15.....
- 16.....
- 17.....
- 18.....
- 19.....
- 20.....
- 21.....
- Fig. B.....
- 22.....
- 23.....
- 24.....
- 25.....
- 26.....
- 27.....
- 28-29.....

Anatomy Test Sheets

8210 Spinal Column, Vertebrae

Name _____

Class _____

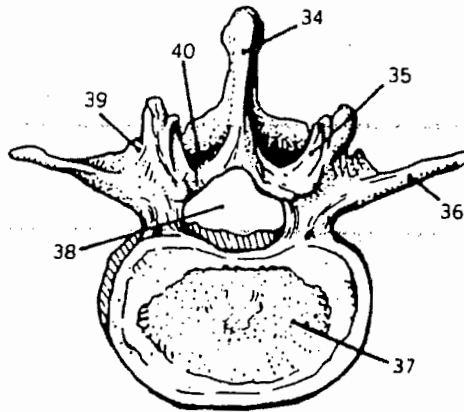
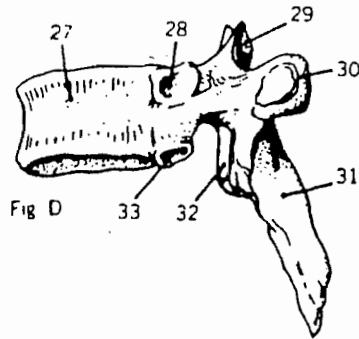
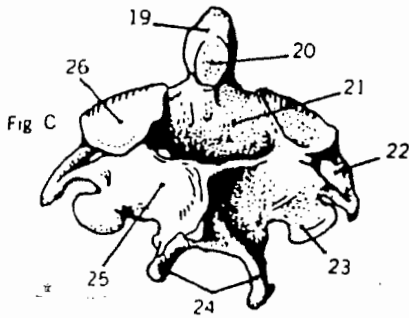
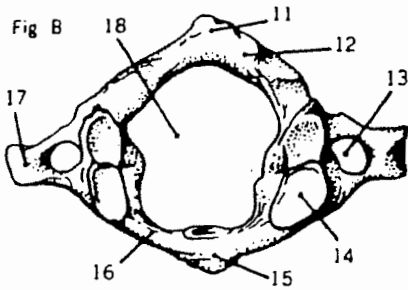
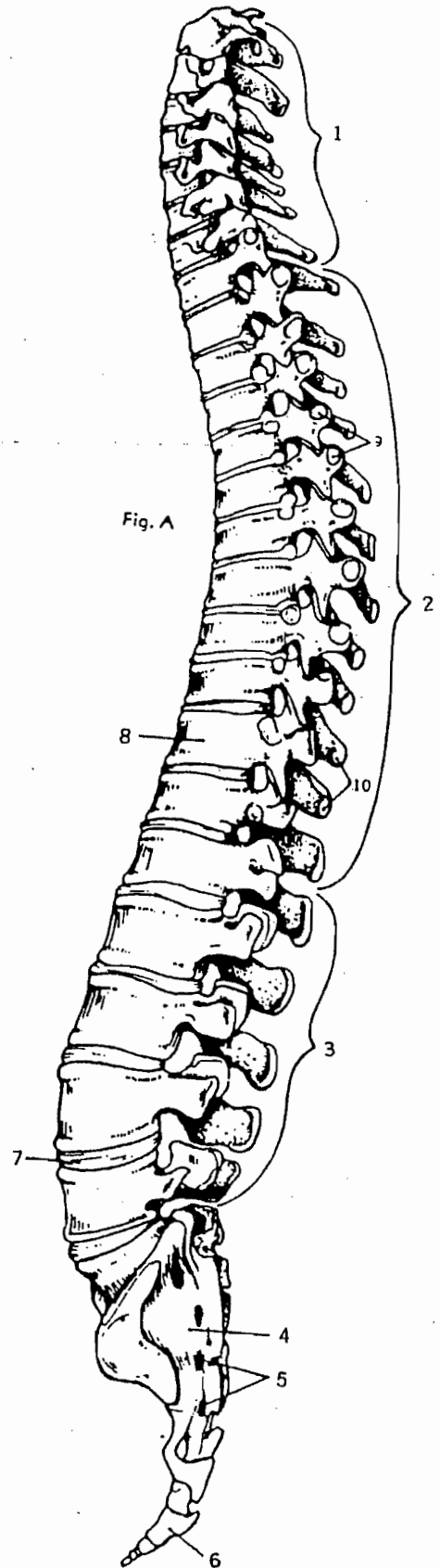

Fig E

Fig. A



- 1 _____
- 2 _____
- 3 _____
- 4 _____
- 5 _____
- 6 _____
- 7 _____
- 8 _____
- 9 _____
- 10 _____
- 11 _____
- 12 _____
- 13 _____
- 14 _____
- 15 _____
- 16 _____
- 17 _____

- 18 _____
- 19 _____
- 20 _____
- 21 _____
- 22 _____
- 23 _____
- 24 _____
- 25 _____
- 26 _____
- 27 _____
- 28 _____
- 29 _____
- 30 _____
- 31 _____
- 32 _____
- 33 _____
- 34 _____
- 35 _____
- 36 _____
- 37 _____
- 38 _____
- 39 _____
- 40 _____

DENOYER-GEPPERT

CHICAGO, ILLINOIS 60640

Anatomy Test Sheets

Name _____

Class _____

8212 Bones of the Foot

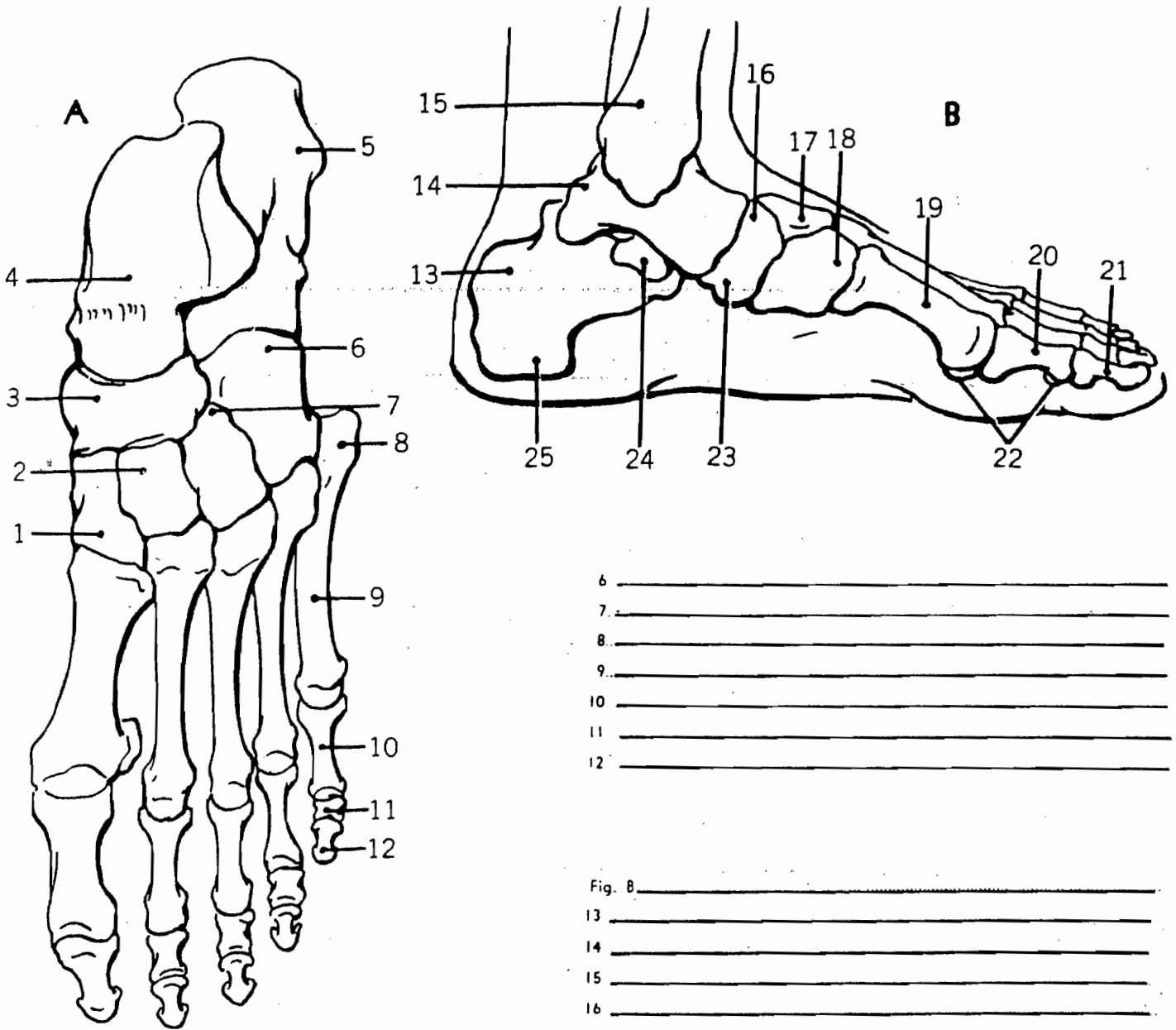

6 _____

7 _____

8 _____

9 _____

10 _____

11 _____

12 _____

Fig. B _____

13 _____

14 _____

15 _____

16 _____

17 _____

18 _____

19 _____

20 _____

21 _____

22 _____

23 _____

24 _____

25 _____

Fig. A _____

1 _____

2 _____

3 _____

4 _____

5 _____

DENOYER-GEPPERT

CHICAGO, ILLINOIS 60640

Anatomy Test Sheets

Name _____

Class _____

8213 Bones of the Hand

A. Dorsal Surface

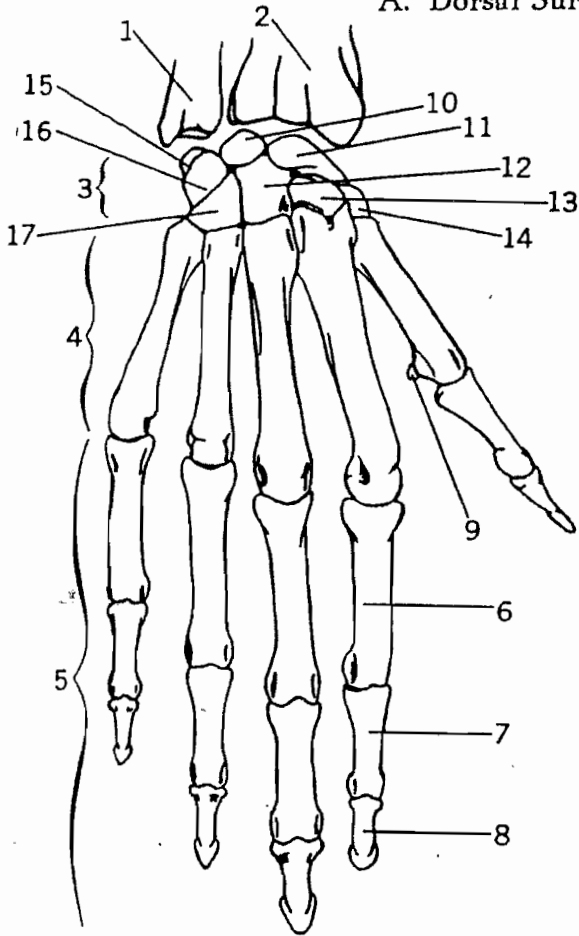

- 1 _____
- 2 _____
- 3 _____
- 4 _____
- 5 _____
- 6 _____
- 7 _____
- 8 _____
- 9 _____

- 10 _____
- 11 _____
- 12 _____
- 13 _____
- 14 _____
- 15 _____
- 16 _____
- 17 _____

B. Interior Surface

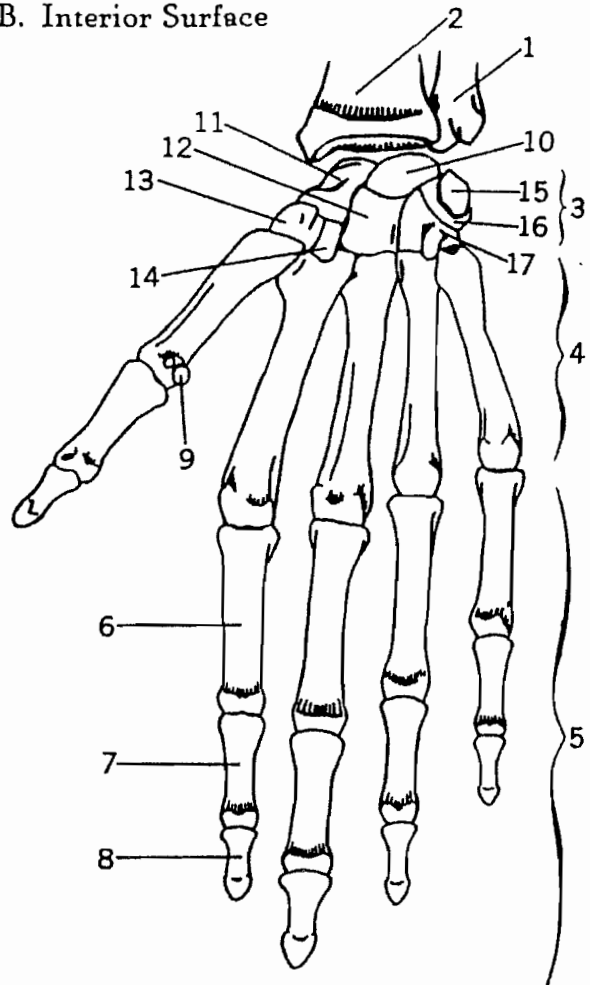

DENOYER-GEPPERT

CHICAGO, ILLINOIS 60640

Anatomy Test Sheets

8215 Male, Female Bony Pelvis

Name _____

Class _____

Fig. A

- 1 _____
- 2 _____
- 3 _____
- 4 _____
- 5 _____
- 6 _____
- 7 _____
- 8 _____
- 9 _____
- 10 _____
- 11 _____
- 12 _____
- 13 _____
- 14 _____

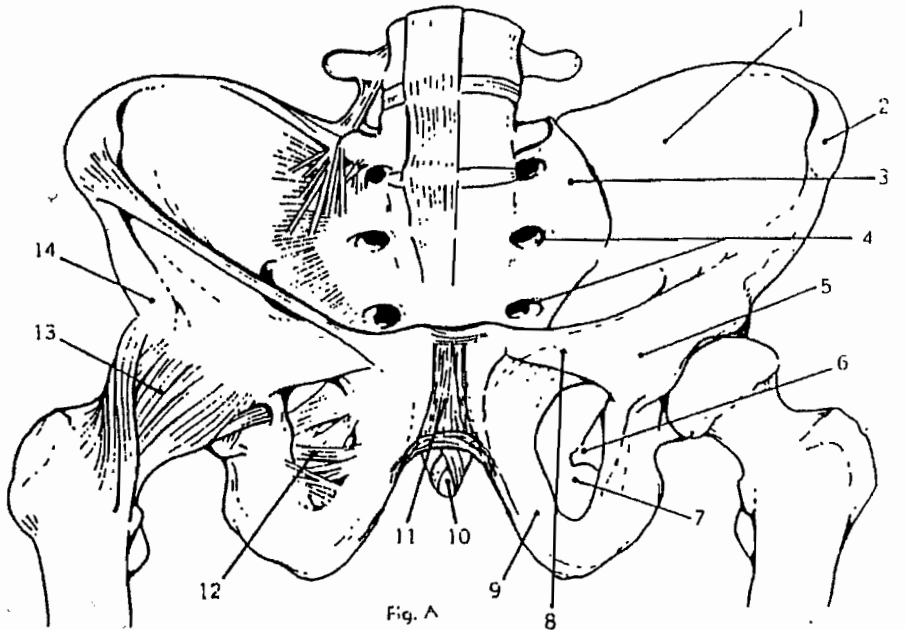
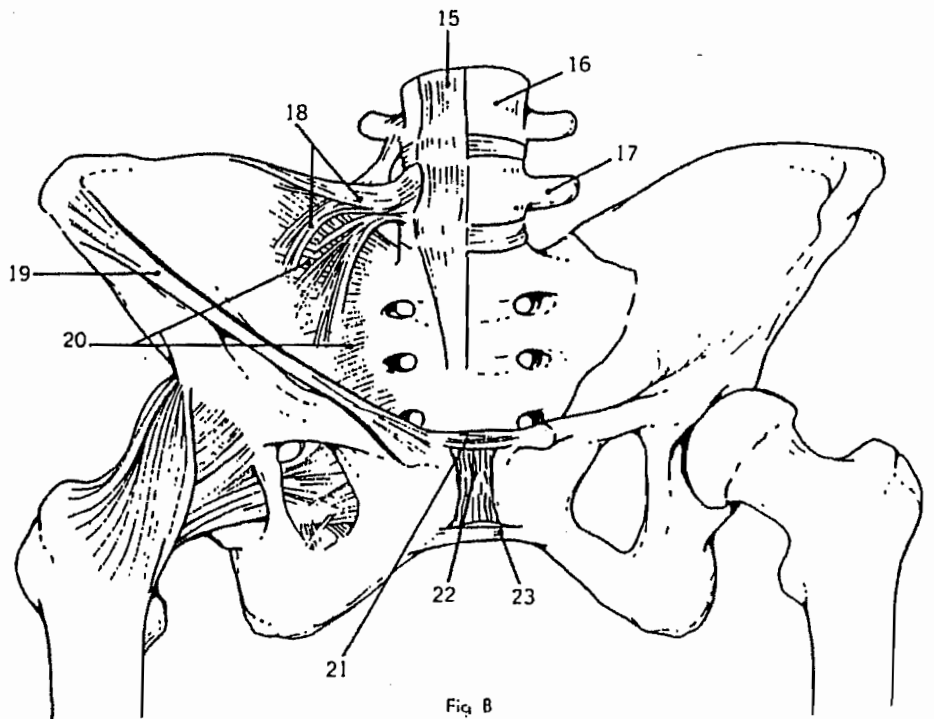

Fig. B

- 15 _____
- 16 _____
- 17 _____
- 18 _____
- 19 _____
- 20 _____
- 21 _____
- 22 _____
- 23 _____



DENOYER-GEPPERT

CHICAGO, ILLINOIS 60640

Anatomy Test Sheets

Name _____

8216 Ilium, two views

Class _____

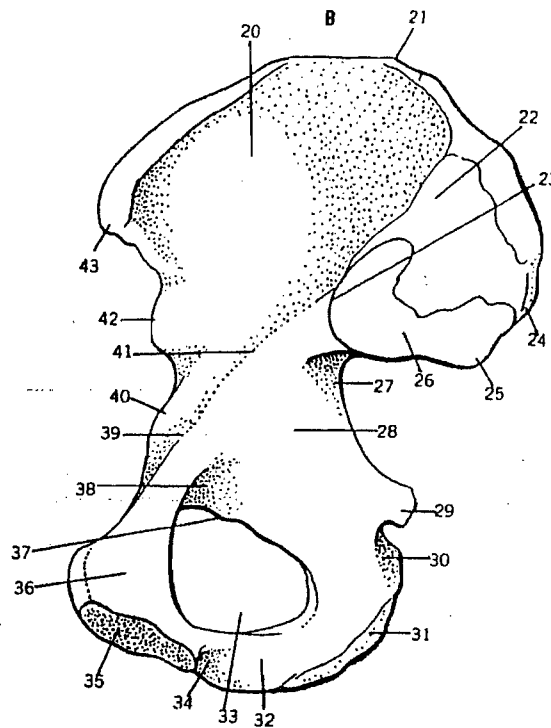
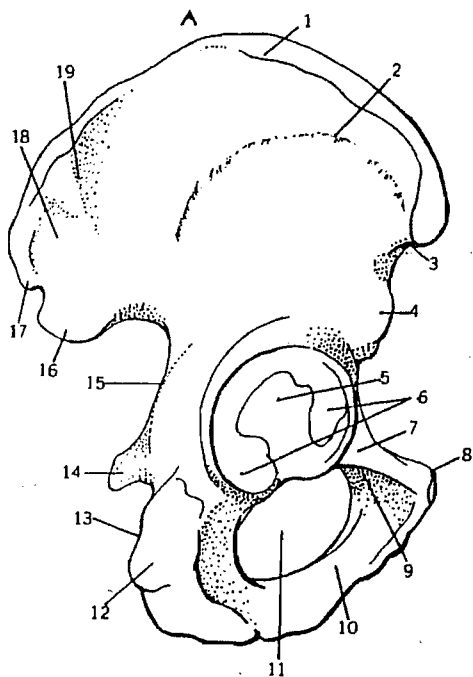

Fig. A.....

- 1.....
- 2.....
- 3.....
- 4.....
- 5.....
- 6.....
- 7.....
- 8.....
- 9.....
- 10.....
- 11.....
- 12.....
- 13.....
- 14.....
- 15.....
- 16.....
- 17.....
- 18.....
- 19.....

Fig. B.....

- 20.....

- 21.....
- 22.....
- 23.....
- 24.....
- 25.....
- 26.....
- 27.....
- 28.....
- 29.....
- 30.....
- 31.....
- 32.....
- 33.....
- 34.....
- 35.....
- 36.....
- 37.....
- 38.....
- 39.....
- 40.....
- 41.....
- 42.....
- 43.....

DENOYER-GEPPERT

CHICAGO, ILLINOIS 60640

Anatomy Test Sheets

Name _____

Class _____

8217 Scapula, two views

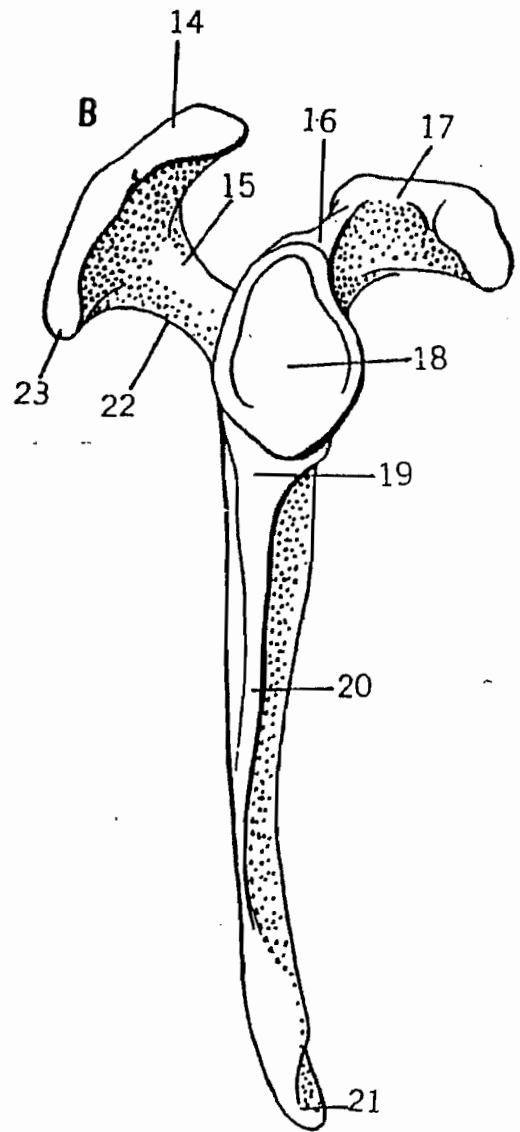
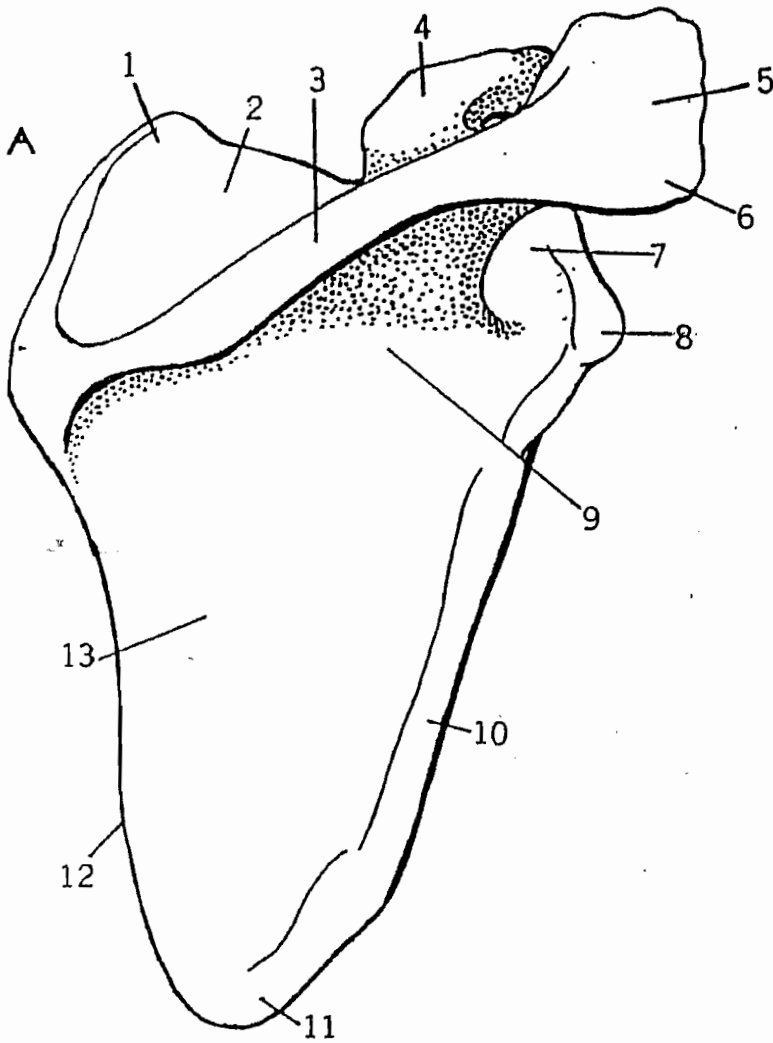

- Fig. A _____
- 1 _____
 - 2 _____
 - 3 _____
 - 4 _____
 - 5 _____
 - 6 _____
 - 7 _____
 - 8 _____
 - 9 _____
 - 10 _____
 - 11 _____
 - 12 _____
 - 13 _____

- Fig. B _____
- 14 _____
 - 15 _____
 - 16 _____
 - 17 _____
 - 18 _____
 - 19 _____
 - 20 _____
 - 21 _____
 - 22 _____
 - 23 _____

DENOYER-GEPPERT

CHICAGO, ILLINOIS 60640

Anatomy Test Sheets

Name _____

8218 Large Bones of Upper Extremities

Class _____

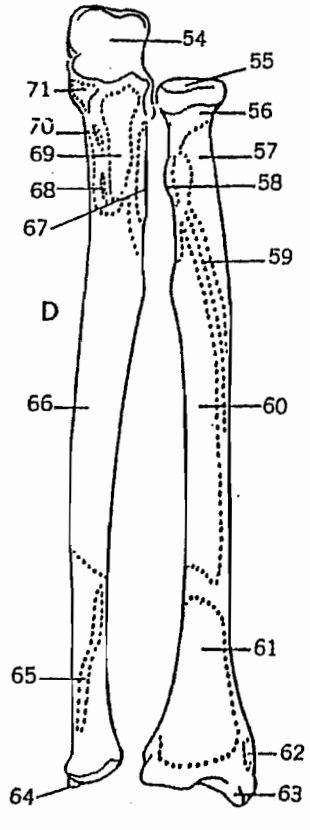
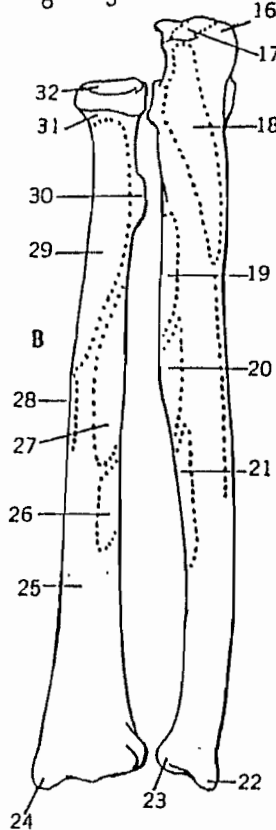
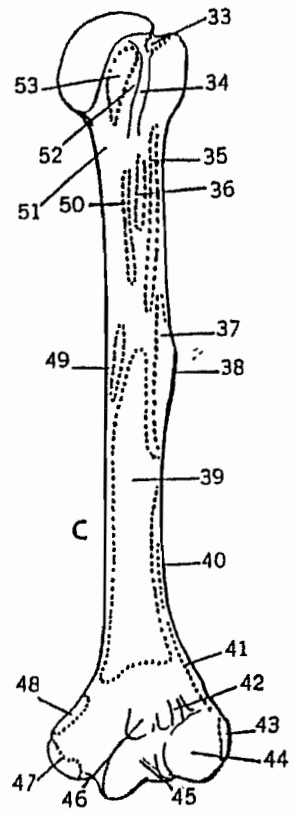
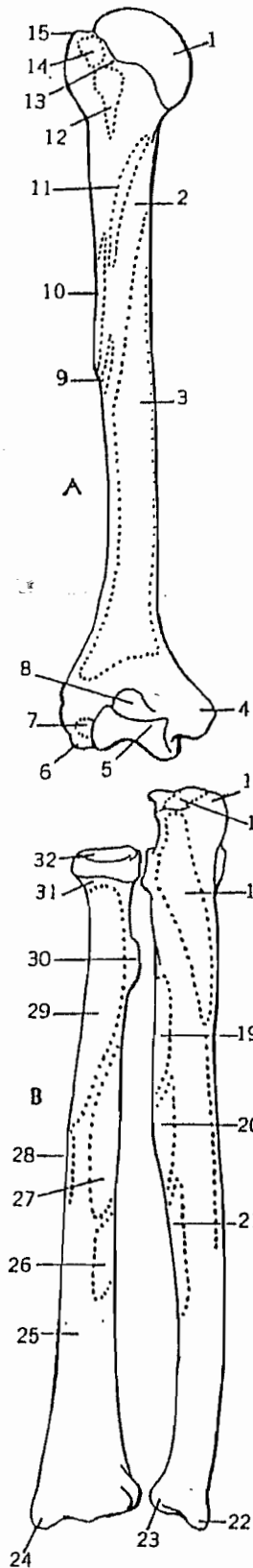

- 4.....
- 5.....
- 6.....
- 7.....
- 8.....
- 9.....
- 10.....
- 11.....
- 12.....
- 13.....
- 14.....
- 15.....
- Fig. B.....
- 16.....
- 17.....
- 18.....
- 19.....
- 20.....
- 21.....
- 22.....
- 23.....
- 24.....
- 25.....
- 26.....
- 27.....
- 28.....
- 29.....
- 30.....
- 31.....
- 32.....
- Fig. C.....
- 33.....
- 34.....
- 35.....
- 36.....
- 37.....
- 38.....
- 39.....
- 40.....
- 41.....
- 42.....
- 43.....
- 44.....
- 45.....
- 46.....
- 47.....
- 48.....
- 49.....
- 50.....
- 51.....
- 52.....
- 53.....
- Fig. D.....
- 54.....
- 55.....
- 56.....
- 57.....
- 58.....
- 59.....
- 60.....
- 61.....
- 62.....
- 63.....
- 64.....
- 65.....
- 66.....
- 67.....
- 68.....
- 69.....
- 70.....
- 71.....

Fig. A.....
1.....
2.....
3.....

Anatomy Test Sheets

8219 Large Bones of Lower
Extremities

Name _____

Class _____

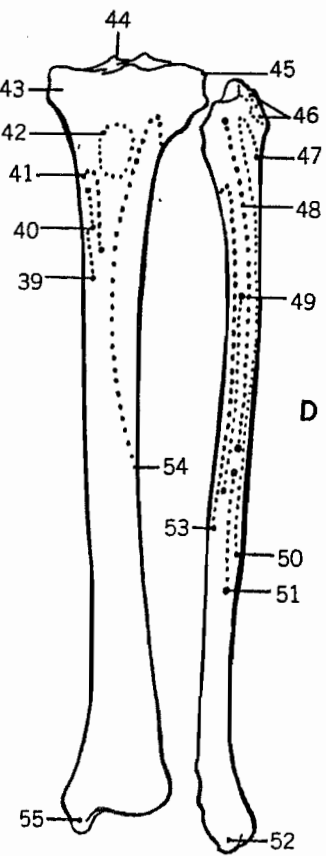
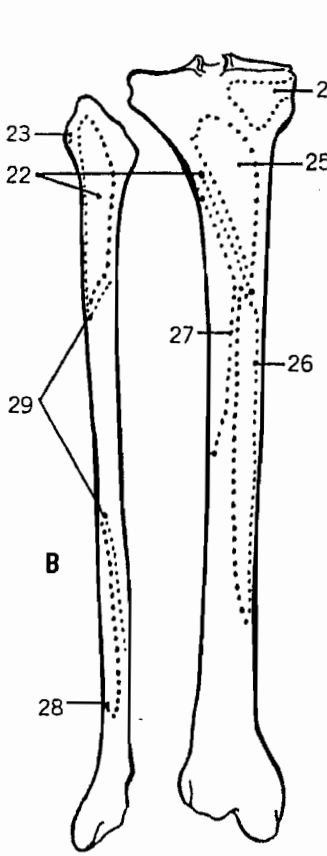
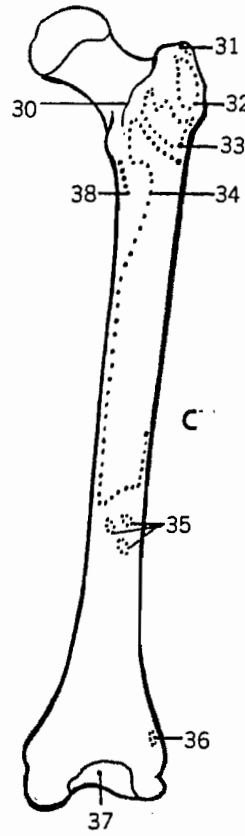
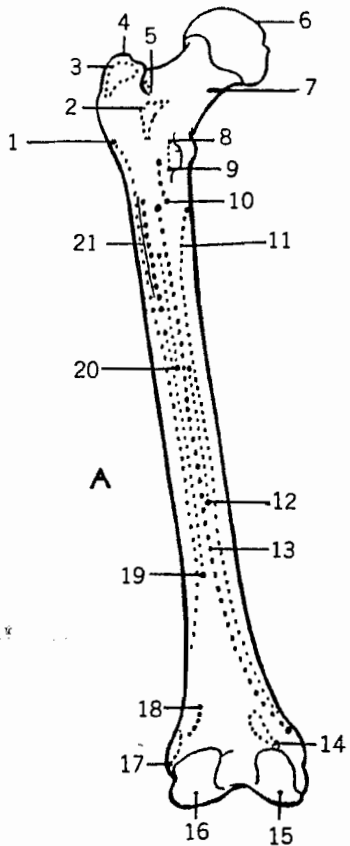

- Fig. A.....
- 1.....
 - 2.....
 - 3.....
 - 4.....
 - 5.....
 - 6.....
 - 7.....
 - 8.....
 - 9.....
 - 10.....
 - 11.....
 - 12.....
 - 13.....
 - 14.....
 - 15.....
 - 16.....
 - 17.....
 - 18.....
 - 19.....
 - 20.....
 - 21.....

- Fig. B.....
- 22.....
 - 23.....
 - 24.....
 - 25.....
 - 26.....
 - 27.....
 - 28.....
 - 29.....

- Fig. C.....
- 30.....
 - 31.....
 - 32.....
 - 33.....
 - 34.....
 - 35.....
 - 36.....
 - 37.....
 - 38.....

- Fig. D.....
- 39.....
 - 40.....
 - 41.....
 - 42.....
 - 43.....
 - 44.....
 - 45.....
 - 46.....
 - 47.....
 - 48.....
 - 49.....
 - 50.....
 - 51.....
 - 52.....
 - 53.....
 - 54.....
 - 55.....

DENOYER-GEPPERT

CHICAGO, ILLINOIS 80840